

3D Shapes

Mini Book



Name: _____

3D Shapes

Mini Book



Name: _____

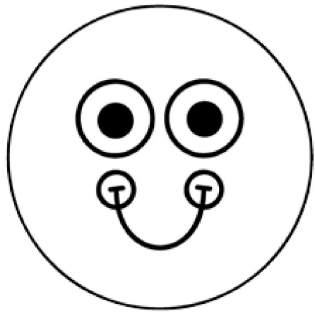

Write:

sphere

V: _____

E: _____

F: _____

Trace:

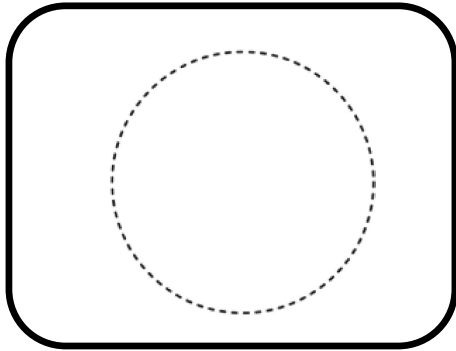

Draw:



A _____ looks like _____

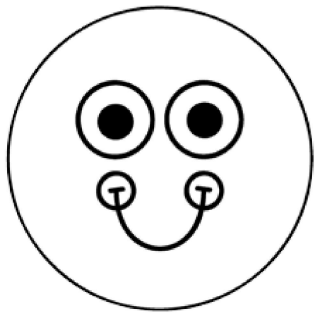

Write:

sphere

V: _____

E: _____

F: _____

Trace:

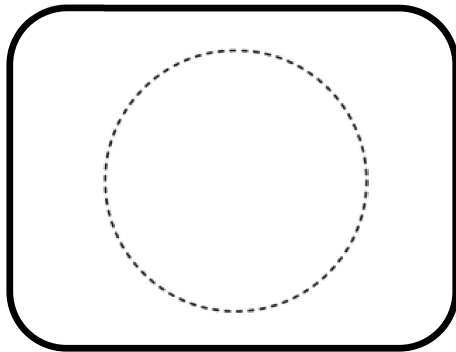

Draw:

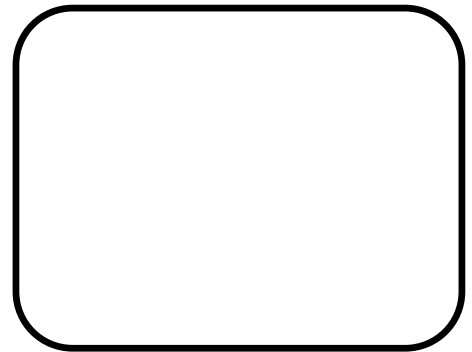

A _____ looks like _____

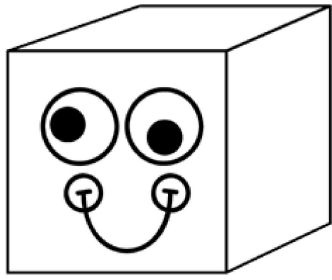

Write:

cube

V: _____

E: _____

F: _____

Trace:

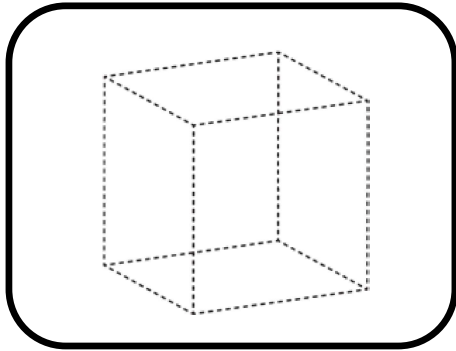

Draw:



A _____ looks like _____

.

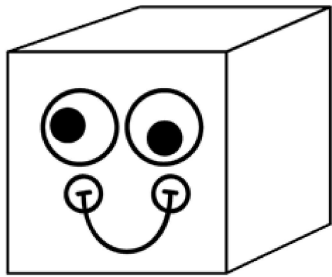

Write:

cube

V: _____

E: _____

F: _____

Trace:

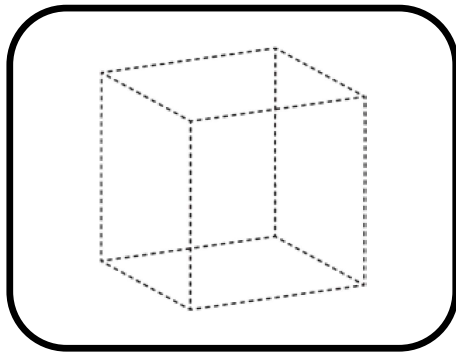

Draw:

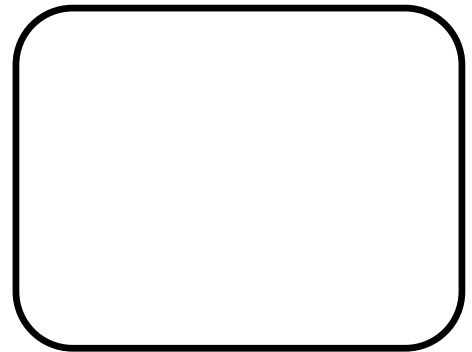

A _____ looks like _____

.

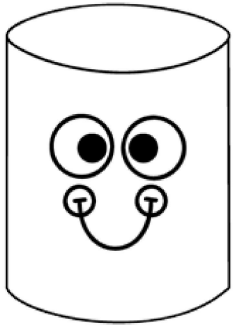

Write:

cylinder

V: _____

E: _____

F: _____

Trace:

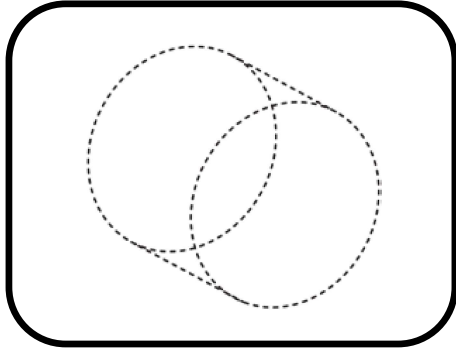

Draw:



A _____

looks like _____

.

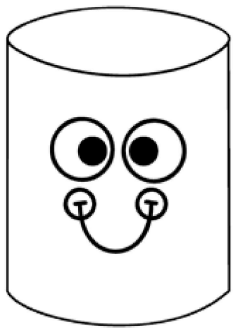

Write:

cylinder

V: _____

E: _____

F: _____

Trace:

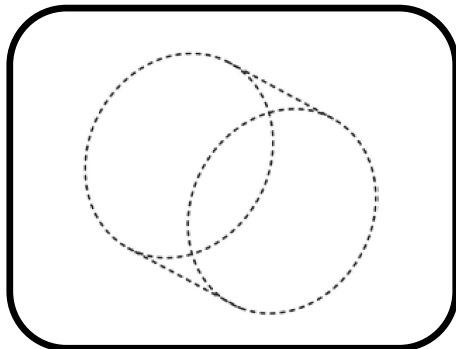

Draw:

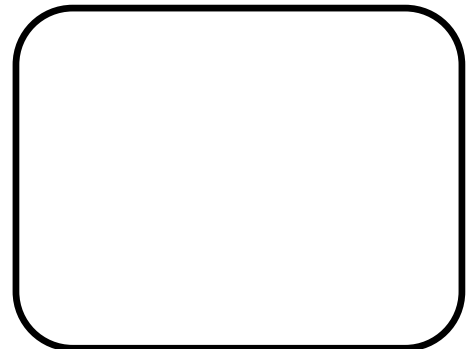

A _____

looks like _____

.

Write:

rectangular prism

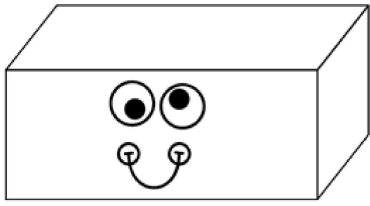

V: _____ E: _____ F: _____

Trace:

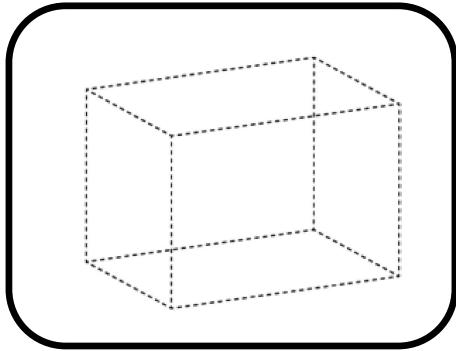

Draw:



A _____ looks like _____

Write:

rectangular prism

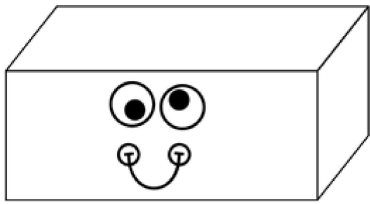

V: _____ E: _____ F: _____

Trace:

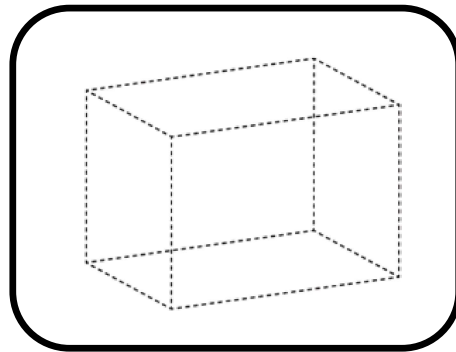

Draw:

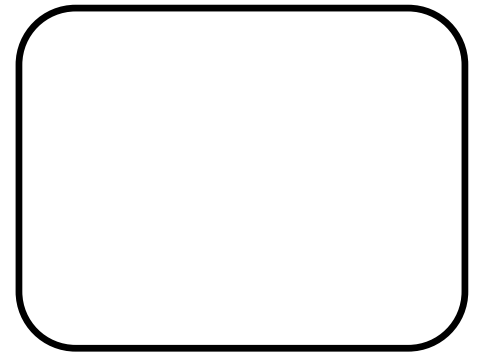

A _____ looks like _____

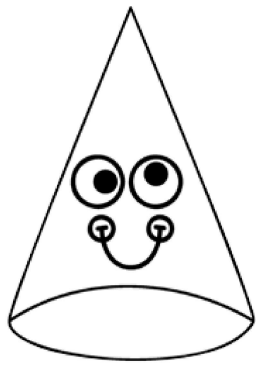

Write:

cone

V: _____

E: _____

F: _____

Trace:

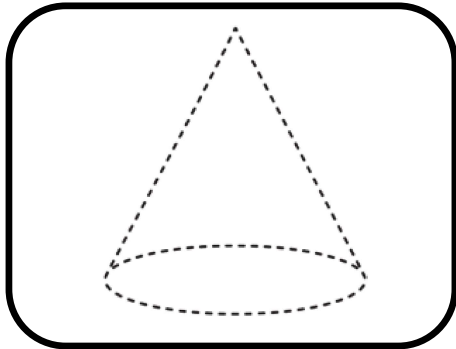

Draw:



A _____ looks like _____

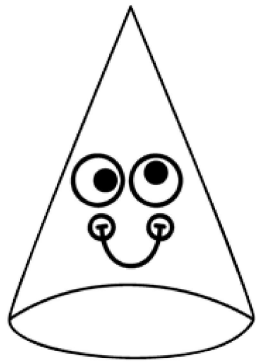

Write:

cone

V: _____

E: _____

F: _____

Trace:

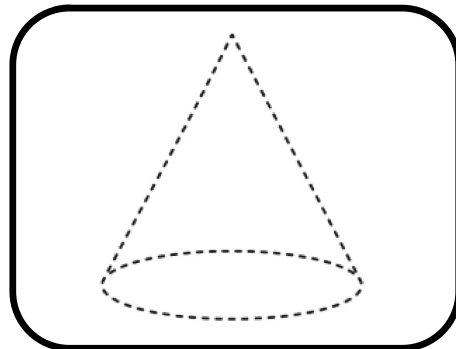

Draw:

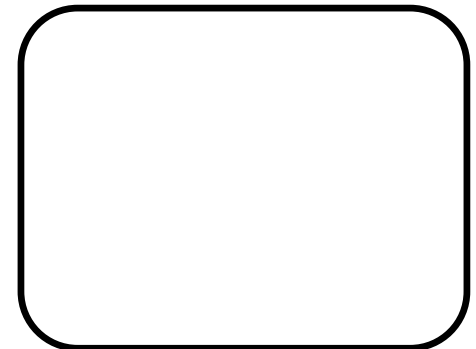

A _____ looks like _____

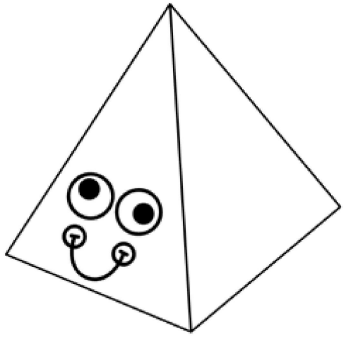

Write:

pyramid

V: _____

E: _____

F: _____

Trace:

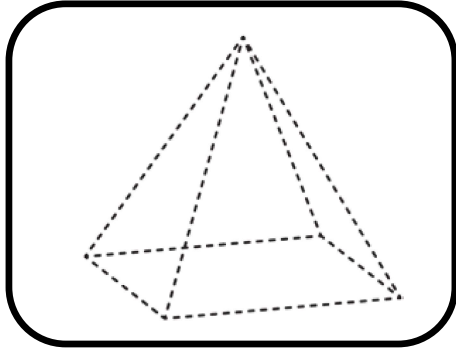

Draw:



A _____ looks like _____

_____.

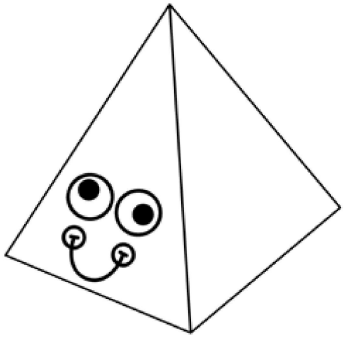

Write:

pyramid

V: _____

E: _____

F: _____

Trace:

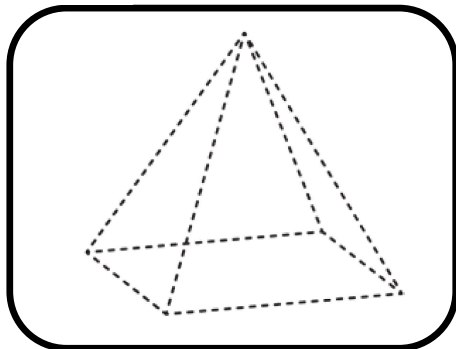

Draw:

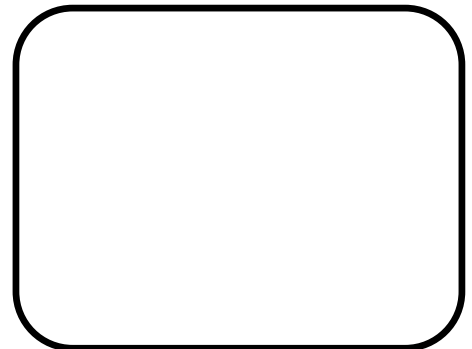

A _____ looks like _____

_____.